

DIMENSIONS

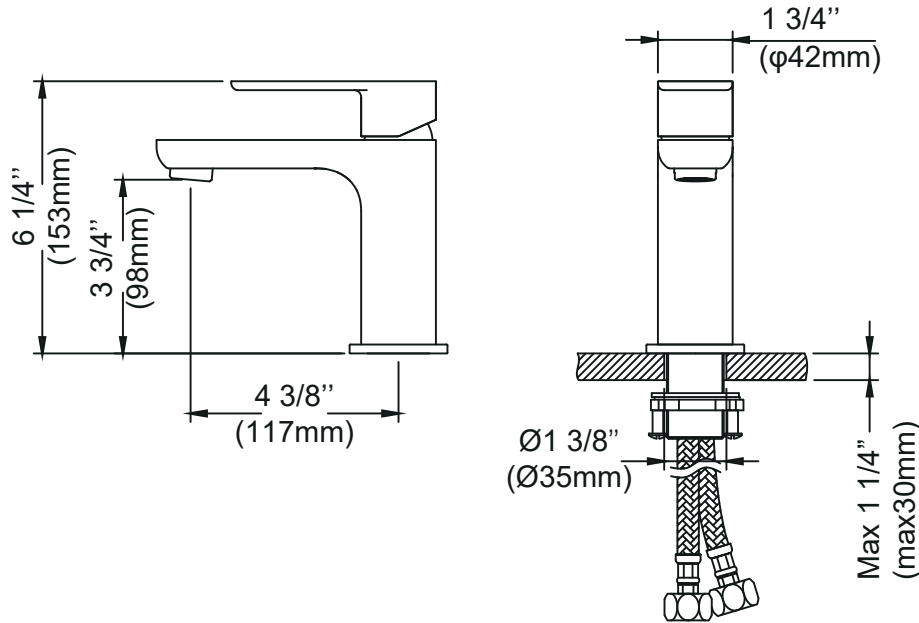

INSTALLATION INSTRUCTIONS

Single Handle Lavatory Faucet

F01 119

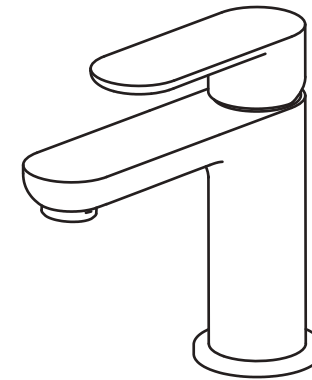

BLOSSOM BRAND FAUCETS LIMITED LIFETIME WARRANTY

- Blossom solid brass faucets are manufactured with the most durable ceramic cartridge under the highest standards of quality and workmanship. All Blossom faucets carry a limited lifetime warranty from the original date of purchase.
- We recommend our products to be installed and serviced by a licensed professional plumber or contractor to avoid any improper installation. Warranty is automatically void if any product has been tampered, improperly installed, altered or damaged due to misuse or abuse during installation.
- If a product fails as a result of a defect in manufacturing during the warranty period, Blossom will repair or replace the product or its parts at its sole discretion. Proof of purchase (original invoice / sales receipt) must be provided to Blossom for all warranty claims. The warranty applies only to faucets installed in the United States of America & Canada. Blossom extends its warranty only to the first consumer purchaser.
- BLOSSOM IS NOT LIABLE FOR ANY INCIDENTAL, CONSEQUENTIAL OR ACCIDENTAL DAMAGES, LABOR CHARGES, TRAVEL TIME, FREIGHT COSTS INCURRED OR CONTINGENT LIABILITIES.
- Blossom, makes no representation that its products comply with any or all local building or plumbing codes. It is the consumer's responsibility for determining local code compliance.

www.BlossomUS.com



NSF



Lead Free Solid Brass Faucet
CITEC Ceramic Cartridge From Spain
Neoperl Aerator 1.5GPM From Switzerland
 cUPC Stainless Steel Waterlines

www.BlossomUS.com

Important

- We recommend that this product is installed by a qualified professional plumber / contractor.
- Please check this product immediately to ensure that it has not been damaged and is complete. Before installation, please make sure this product is the correct model and you have all the parts required for installation and using.
- Please flush the water system to ensure that no metal swarf, solder, and other impurities can enter the taps.
- Turn off water supply before commencing work, this should be done at the isolating valves of inlet feeds if fitted or main stopcock.
- Please read these instructions carefully and keep it for future reference.

Cleaning

- Before use: Unscrew the Aerator and allow the water to run freely for 5 minutes. Then screw the filter back in place.
- Periodically: Unscrew the Aerator and remove. Rinse it with running water until any loose debris is cleared. Then replace the Aerator and tighten.

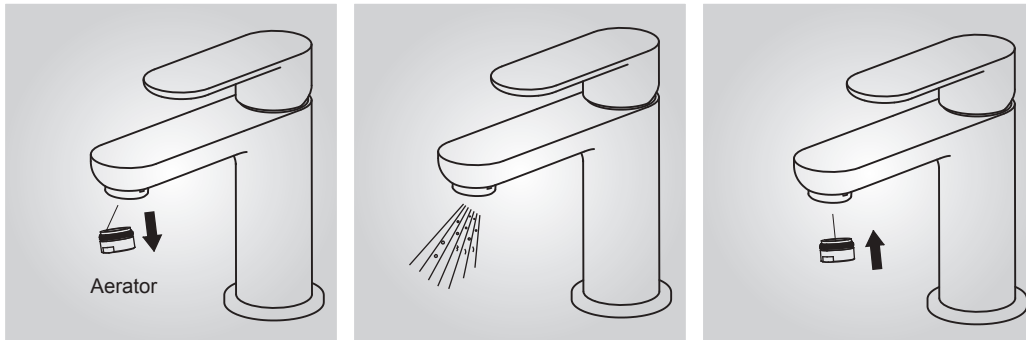

Maintenance

We DO NOT recommend using any household cleaners to clean the product. The product should be cleaned only with soapy water. Rinsed with clean water and dry with a soft cloth.

Faucet Installation Procedure

Recommended Tools

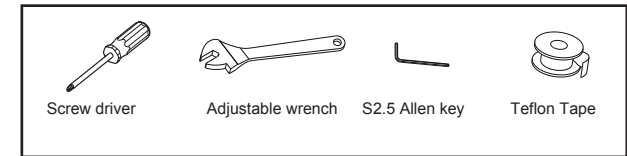

Shut off main water supply before installation

1. Fit the washer into the groove at the underside of the mixer body.

2. Screw the hoses into the mixer body, and fully hand tighten.

3. Pass the tail of flexible pipes through the hole on the basin from above, and place the mixer in position on the basin, to see if any alteration to the existing supply pipe work is necessary, make any necessary alterations to the pipe work.

4. Tighten the rubber washer, the metal washer with the fixing nut from the under-side of the counter.

5. Check that the mixer body is correctly positioned, fully tighten the fixing nut.

6. Connect the water supply pipes to the tail of flexible hoses with the hot and cold water.

